



Fixtures for LED Tubes

americanlite[®]

We light your world[™]





PST™ Series

2', 4' & 8' LED Tube Ready Strip

The PST™ Series is a functional multi-purpose Industrial grade strip family that incorporates premium performance and construction durability. Designed with our prewire UL rated sockets, the PST™ Series significantly reduces installation time. The performance and application versatility of this series can be increased by incorporating Americanlite® LED Tubes.

Rated for Dry and Damp location, The PST™ Series channel and cover are made of gauge 22 code compliant die-formed cold-rolled galvanized steel, painted with powder coat white finish. Wires are UL758, 18AWG 105°C 600V rated. The PST™ Series can be installed surface or pendant mounting, with numerous options and accessories that includes wireguards & ER Drivers.

The PST™ Series can be the illumination solution in commercial, industrial, retail and residential applications. Designed for large commercial spaces, can be mounted in a continuous row as well. The PST™ Series can be used in warehouses, storage/utility areas, coves, display cases, shops, task and general area lighting.

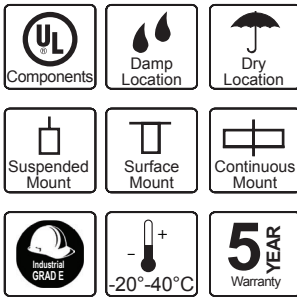

Dimensions (mm / ft)

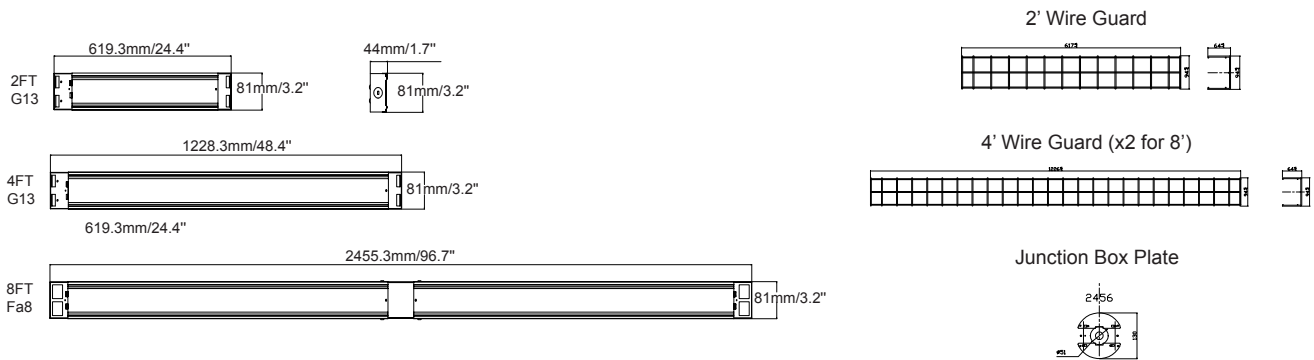

Ordering information

Item

AL512060 2'
AL512061 4'
AL512062 8'

Options

Blank Wired for 1 end (2' & 4')
B Wired for 2 ends (2' & 4')
ER 5w ER Battery 90 min
Q Quick Connectors

Accessories:

AL512063 2' Wire Guard (618x94mm)
AL512064 4' Wire Guard (1226x94mm)
AL512065 8' Wire Guard (1226x94mm, 2x4')
AL512066 Suspension Chain Kit
AL512067 Continuous Row Mounting Bracket

Notes

- Body = Galvanized Steel / white powder coat finish
- Body Thickness = 0.6mm / Gauge 22
- 8 Knockouts / Diameter 1/2"
- Wire= UL758, 18AWG Rated temp. 105°C Rate Voltage: 600V
- 2' / 4' = Prewired single or double ended G13 Tubes
- 8' = Prewired double ended G13 or FA8 Tubes
- Pig tail length = 150mm
- UL Listed Lampholders:
- G13 lampholder = single ended input, Non-Shunted sockets 600V rated
- FA8 lampholder = 600V rated
- ER Battery for 4' & 8' #IN-ECP-LED-5-500-AC
- Wire Guard = Steel
- Galvanized Steel junction box cover plate included
- Stainless Steel "V" Hooks included
- Suspension Chain Kit = 1m
- Quick Connectors: Both sides of each fixture For Continuous Row Max Linkable Power = 330w 2FT: 9w (9*2=18w) Max 18pcs 4FT: 26w (26*2=52w) Max 6pcs 8FT: FA8 42w (42*2=84w) Max 4pcs



Packing information

Model	PCS / Box	Master Box (cm)	CBM (box)	GW (KGS)
2'	6	65 x 28.5 x 13	0.0240	6.1
4'	6	125.5 x 28.5 x 13	0.0464	10.54
8'	4	248.5 x 19.5 x 13	0.0630	12.6

Model	PCS / Box	Master Box (cm)	CBM (box)	GW (KGS)
2' Wire Guard	2	64 x 11.5 x 8.2	0.0060	0.93
4' Wire Guard	2	124.5 x 11.5 x 8.2	0.0120	1.62
8' Wire Guard (2*4')	2	124.5 x 11.5 x 8.2	0.0120	1.62
Chain Kit	10	20 x 21.5 x 10	0.0043	2.4

Paralite E™ Series For T8 LED Tubes



IP20	 Indoor only	 120° Beam
VOLTS 100-277	PF 0.50	CCT 3K-65K
CRI 70	2 YEAR Warranty	

Americanlite® Paralite E™ Series is a breakthrough in LED lighting combining a heavy-duty housing with a high efficiency louver to provide comfortable and precise lighting on every recessed application.

Americanlite® Paralite E™ Series housing is die-formed and embossed steel 0.40mm thickness. Our five-stage iron-phosphate pre-treatment ensures superior paint adhesion and rust resistance. Housing painted after fabrication with environmentally friendly, high gloss, very high reflectivity polyester powder coat. AA type parabolic louvers are formed from aluminum with mirror finish to increase visual comfort. Lampholders are PC fireproof.

Americanlite® Paralite E™ Series provides a high performance T8 energy saving for today's low energy consumption requirements. Is ideal for commercial spaces, such as offices, stairwells, hallways, utility rooms, schools, data centers and much more.

Dimensions (mm)

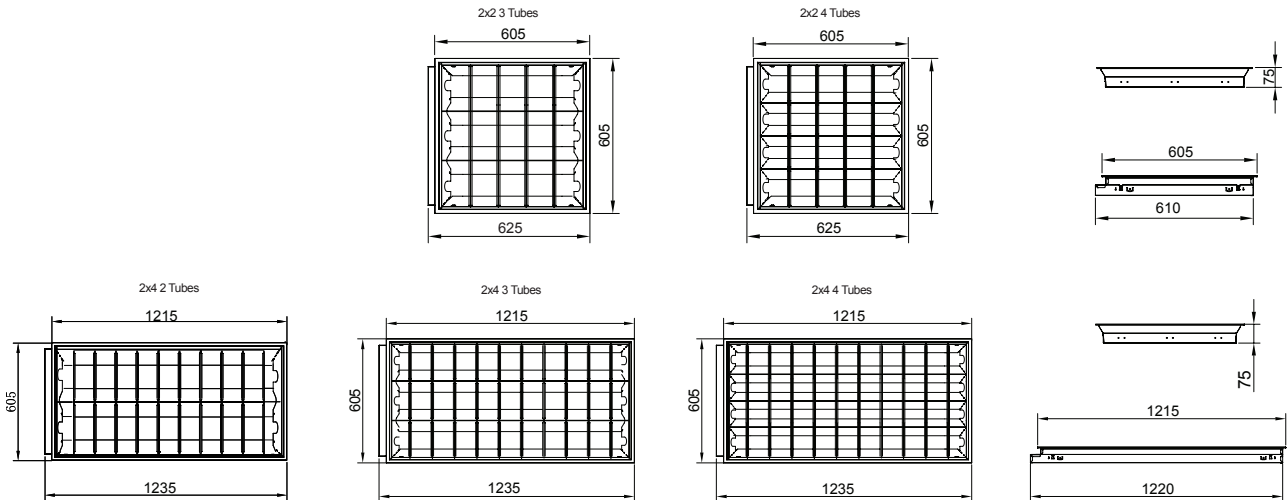

Ordering information

Without Tubes

Item	Size	Configuration	Cells	Louver Type	Louver Finish	Wiring Options
AL512009	2x2	4 tubes	20 (4x5)	Blank Double Louver	Blank Mirror	Blank One end power
AL512008	2x2	3 tubes	15 (3x5)			2 Two end Power

Item	Size	Configuration	Cells	Louver Type	Louver Finish	Wiring Options
AL512011	2x4	4 tubes	44 (4x11)	Blank Double Louver	Blank Mirror	Blank One end power
AL512010	2x4	3 tubes	33 (3x11)			2 Two end Power
AL512017	2x4	2 tubes	33 (3x11)			

With Tubes

Item	Size	Configuration	Cells	Louver Type	Louver Finish	Wiring Options
AL512013	2x2	4 tubes	20 (4x5)	Blank Double Louver	Blank Mirror	Blank One end power
AL512012	2x2	3 tubes	15 (3x5)			2 Two end Power

Item	Size	Configuration	Cells	Louver Type	Louver Finish	Wiring Options
AL512014	2x4	4 tubes	44 (4x11)	Blank Double Louver	Blank Mirror	Blank One end power
AL512015	2x4	3 tubes	33 (3x11)			2 Two end Power
AL512016	2x4	2 tubes	22 (2x11)			

Notes

• Lumens based on 65K/5K:
4000K = 5% less
3000K = 10% less

• Lumens for 2x2:
4 x 9w tubes = 2253 lm
3 x 9w tubes = 1690 lm

• Lumens for 2x4:
4 x 18w tubes = 4340 lm
3 x 18w tubes = 3255 lm
2 x 18w tubes = 2170 lm

Packing information

Model	CBM/master	Pieces/Carton	Carton (cm)	Gross wt (kg)
2x2	0.0331	1	63.5 x 8.5 x 61.5	3.1
2x4	0.0648	1	124.5 8.5 x 61.5	4

Troffer Series

For T8 LED Tubes



IP20	Indoor only	120° Beam
VOLTS 100-277	PF 0.50	CCT 3K-65K
CRI 70	2 YEAR Warranty	

Americanlite® Troffer Series is a breakthrough in LED lighting combining a heavy-duty housing with a high efficiency lens to provide comfortable and general lighting on every recessed application.

Americanlite® Troffer Series housing is die-formed and embossed steel 0.40mm thickness. Our five-stage iron-phosphate pre-treatment ensures superior paint adhesion and rust resistance. Housing painted after fabrication with environmentally friendly, high gloss, very high reflectivity polyester powder coat. High transmission Prismatic diffuser, made of PS material with 1.2mm thickness for excellent light distribution. Lampholders are PC fireproof.

Americanlite® Troffer Series provides a high performance T8 energy saving for today's low energy consumption requirements. Is ideal for commercial spaces, such as offices, stairwells, hallways, utility rooms, schools, data centers and much more.

Dimensions (mm)

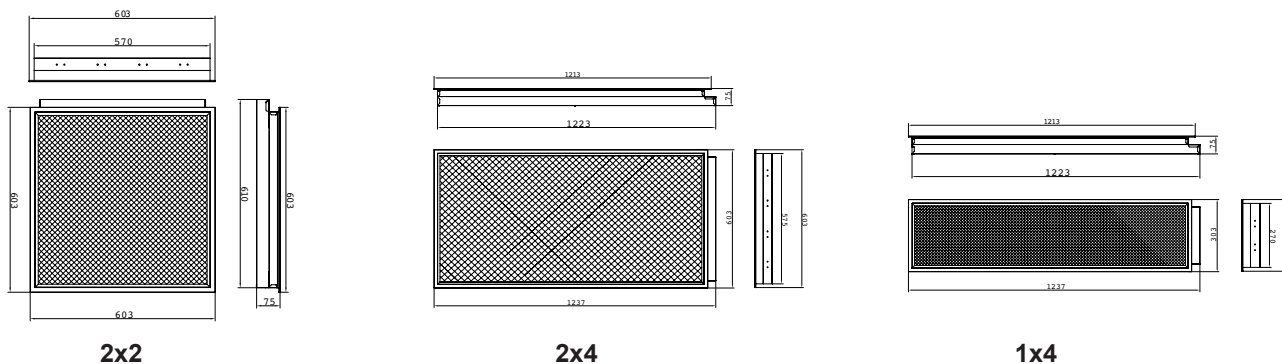

Ordering information

Without Tubes

Item	Size	Wiring Configuration for 2x2 & 2x4	Wiring Options
AL512030	2x2	Blank for 4 LED tubes	Blank Double End Power
AL512031	2x4	3 for 3 LED tubes	S Single End Power
AL512032	1x4	2 for 2 LED tubes	

With Tubes

Item	Size	Wiring Configuration for 2x2 & 2x4	CCT	Wiring Options
AL512033	2x2	Blank for 4 LED tubes	Blank 6500K	Blank Double End Power
AL512034	2x4	3 for 3 LED tubes	5 5000K	S Single End Power
AL512035	1x4	2 for 2 LED tubes	4 4000K	
			3 3000K	

Notes

- Lumens based on 65K/5K:
4000K = 5% less
3000K = 10% less
- Lumens for 2x2:
4 x 9w tubes = 2168 lm
3 x 9w tubes = 1626 lm
2 x 9w tubes = 1084 lm
- Lumens for 2x4:
4 x 18w tubes = 5000 lm
3 x 18w tubes = 3750 lm
2 x 18w tubes = 2500 lm
- Lumens for 1x4:
2 x 18w tubes = 2131 lm

Packing information

Model	CBM/master	Pieces/Carton	Individual Color box
			Carton (cm)
2x2	0.0331	1	63.5 x 8.5 x 61.5
2x4	0.0650	1	124.5 x 8.5 x 61.5
1x4	0.0333	1	124.5 x 8.5 x 31.5

WGR™ Series

For T8 LED Tubes



IP20	Indoor only	270° Beam
VOLTS 100-265 100-277	PF 0.50	CCT 3K-65K
CRI 70	Surface Mount	1 YEAR Warranty

Americanlite® WGR™ Series is a breakthrough in LED lighting combining a low profile housing and a high efficiency light control louver to provide comfortable and precise lighting for surface-mount applications.

Americanlite® WGR™ Series is made of iron 0.32mm thickness, with five-stage iron-phosphate pre-treatment ensures superior paint adhesion and rust resistance. Housing is painted after fabrication with environmentally friendly, high gloss, very high reflectivity polyester powder coat. The louver is made of PP 1.2 mm thickness for excellent light control; end caps are ABS and every fixture includes G13, PP lampholders.

Americanlite® WGR™ Series provides a high performance T8 energy saving for today's low energy consumption requirements. Is ideal for commercial and residential spaces, such as offices, stairwells, hallways, utility rooms, kitchens, basements, and much more.

Dimensions (mm)

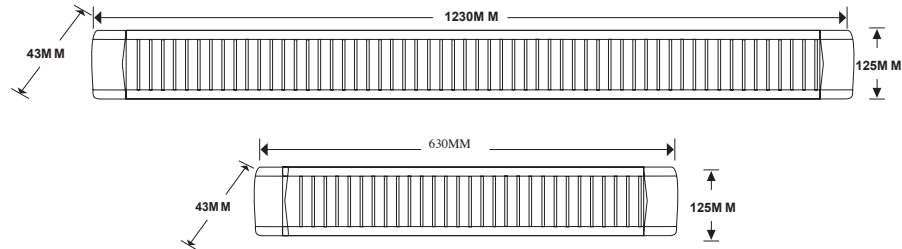

Ordering information

Without Tubes

Item	Size	Wiring Options
AL512060	2'	Blank 1 end power
AL512061	4'	B 2 end power

With Tubes

Item	Size	Watt	Lumens	CCT	Options
AL512062	2'	18w	1440	Blank 6500K	Blank 1 end power
AL512063	4'	36w	2880	5 5000K 4 4000K 3 3000K	B 2 end power 7 100-277

Notes

- Tubes:
 - 2' = 2 x 9w tubes
 - 4' = 2 x 18w tubes
- Lumens base on 65K/5K/4K:
3000K = 10% less



Packing information

Individual Color box

Model	CBM/master	Pieces/Carton	Carton (cm)	G.W. (KGS)
2'	0.0459	10	62 x 28.5 x 26	7.4
4'	0.0926	10	125 x 28.5 x 26	13.5

WLN™ Series

For T8 LED Tubes

IP20	 Indoor only	 270° Beam
VOLTS 100-265 100-277	PF 0.50	CCT 3K-65K
CRI 70	 Surface Mount	1 YEAR Warranty

Americanlite® Wraparound WLN™ Series is a breakthrough in LED lighting combining a low profile housing and a high efficiency lens to provides ambient lighting for surface-mount applications.

Americanlite® WLN™ Series is made of iron 0.32mm thickness, with five-stage iron-phosphate pre-treatment ensures superior paint adhesion and rust resistance. Housing is painted after fabrication with environmentally friendly, high gloss, very high reflectivity polyester powder coat. The lens is made of PC 0.9mm thickness for excellent light distribution; end caps are ABS and every fixture includes G13, PP lampholders.

Americanlite® WLN™ Series provides a high performance T8 energy saving for today's low energy consumption requirements. Is ideal for both residential and commercial spaces, such as laundry rooms, utility rooms, kitchens, basements, stairwells, hallways, and offices.

Dimensions (mm)

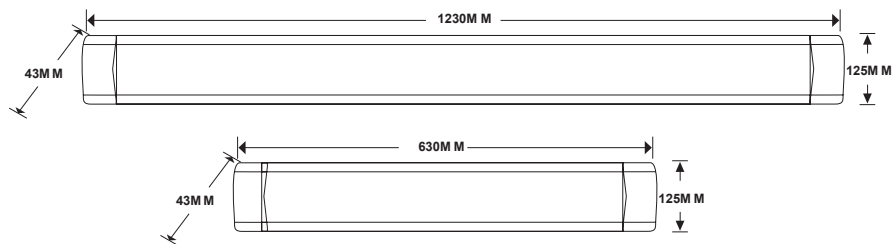

Ordering information

Without Tubes

Item	Size	Wiring Options
AL512064	2'	Blank 1 end power
AL512065	4'	B 2 end power

With Tubes

Item	Size	Watt	Lumens	CCT	Options
AL512066	2'	18w	1260	Blank 6500K	Blank 1 end power
AL512067	4'	36w	2520	5 5000K 4 4000K 3 3000K	B 2 end power 7 100-277

Notes

- Tubes:
 - 2' = 2 x 9w tubes
 - 4' = 2 x 18w tubes
- Lumens base on 65K/5K/4K:
 - 3000K = 10% less

Packing information

Model	CBM/master	Pieces/Carton	Carton (cm)	G.W. (KGS)
2'	0.0459	10	62 x 28.5 x 26	7.4
4'	0.0926	10	125 x 28.5 x 26	13.5

Striplite™

For T8 LED Tubes



The Striplite™ Series is a slim, compact design strip fixture for led tubes, that provides general illumination in residential and light commercial applications. A fully integrated fixture solution that balances performance and economics.

Developed in a low-profile housing, Striplite™ Series incorporates (optional) our latest generation of led tubes. The body is made of steel, 0.25mm thickness after painting. Multistage iron phosphate pretreatment ensures bonding and basic rust inhibitor. Commercial grade lamp holders (sockets) T8, allows a firm and secure connection with led tubes. Single end or 2 end power wiring available.

The Striplite™ Series offers multiple options and combinations to accommodate to your needs, you may order with or without led tubes, “contractor choice” shrink wrap packing, or color pack for retailer operations.

When you use Americanlite® LED tubes, you upgrade your choice, because you make sure you are getting Long-Life LED tubes with state of the art industrial grade technology, to deliver optimal lighting performance.

The Striplite™ Series is the perfect solution for residential, commercial, and some retail applications; can be used in storage/utility areas, shops, task and general area lighting.

Lumens 100LxW	 20,000	VOLTS 100-265
CRI 70	PF >.50	 270° Beam Angle
 -20°C to 40°C	2 YEAR Warranty	

Dimensions

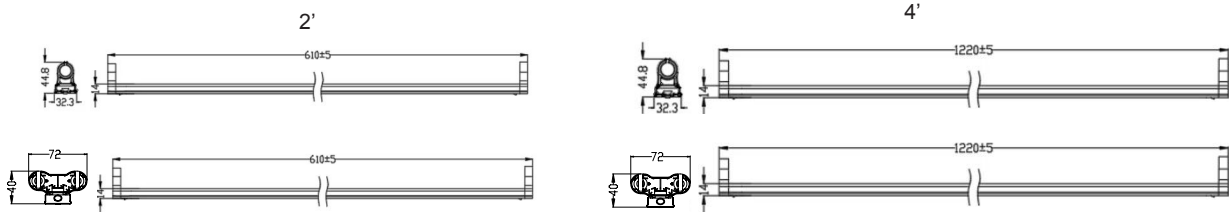

Ordering information

Size/Tube	Item	With Tube			Options	Individual pack:	
		CCT	Watt	Lumens			
2' / 1 Tube	AL512050	6500K	9w	900 lm	Blank	No tube	S Shrink wrap
2' / 2 Tubes	AL512051	6500K	9w	1800 lm	1	Wired one end	C Color box
4' / 1 Tube	AL512052	6500K	18w	1800 lm	2	Wired two ends	
4' / 2 Tubes	AL512053	6500K	18w	3600 lm	L	LED Tubes included	

Notes

- When ordering with tube “L”
LED tubed packed in foam tube
AL573040 18w, Opal, one end power
AL573042 9w, Opal, one end power

Packing information

Shrink Wrap Packing with tubes (2 Tube models are with card board end caps)

Model	CBM/master	Pieces/master	Carton (cm)	G.W. (KGS)
2' / 1 tube	0.0304	24 strips 24 Tubes	65 x 19.5 x 24	5.2
2' / 2 tubes	0.0351	12 strips 24 tubes	65 x 24 x 22.5	6.5
4' / 1 tube	0.0589	24 strips 24 Tubes	126 x 19.5 x 24	10.5
4' / 2 tubes	0.0680	12 strips 24 tubes	126 x 24 x 22.5	8

Shrink Wrap Packing without tubes

Model	CBM/master	Pieces/master	Carton (cm)	G.W. (KGS)
2' for 1 tube	0.0214	50	70 x 18 x 17	5.85
2' for 2 tubes	0.0214	50	70 x 18 x 17	6
4' for 1 tube	0.0397	50	130 x 18 x 17	10
4' for 2 tubes	0.0397	50	130 x 18 x 17	10.15

Color Box Packing with tubes

Model	CBM/master	Pieces/master	Carton (cm)	G.W. (KGS)
2' / 1 tube	0.0344	24 strips 24 Tubes	64.5 x 21.8 x 24.5	6.75
2' / 2 tubes	0.0363	12 strips 24 tubes	64.5 x 24.5 x 23	8
4' / 1 tube	0.0670	24 strips 24 Tubes	125.5 x 21.8 x 24.5	12.2
4' / 2 tubes	0.0707	12 strips 24 tubes	125.5 x 24.5 x 23	9.4

Color Box Packing without tubes

Model	CBM/master	Pieces/master	Carton (cm)	G.W. (KGS)
2' for 1 tube	0.0263	50	71 x 19.5 x 19	6.8
2' for 2 tubes	0.0263	50	71 x 19.5 x 19	6.95
4' for 1 tube	0.0489	50	132 x 19.5 x 19	12.5
4' for 2 tubes	0.0489	50	132 x 19.5 x 19	12.65

Installation kits: inside master carton



Warranty

Americanlite® is pleased to provide a 1, 2 or 5 year limited warranty covering the LED fixtures on this catalogue. Americanlite® warrants that the LED fixtures comply with Americanlite®'s published specifications and are free from defects in materials and workmanship.

All our equipment is CE, ETL or UL approved and manufactured with approved components. Americanlite® reserves the right to change or improve the design or components of any of its products due to parts availability or changes in standards, without assuming any obligation to modify any product previously manufactured and without notice. All equipment is tested and inspected before shipment.

This warranty is void if the product is operated outside of its normal operating conditions. The foregoing warranty does not apply to failures caused by acts of God or as a result of any abuse, misuse, abnormal use, or use in violation of any applicable standard, code or instructions for use in installations, including, but not limited to, those contained in the Standards for the International Electro technical Commission. Americanlite® reserves and has the right to examine failed fixtures to determine the cause of failure, excessive lumen depreciation and patterns of usage.